

DS



DECONTACTOR™ FOR INDUSTRY



30 A/50 A/90 A/150 A/250 A/ 400 A

- ▶ Automatic IP54/55
- ▶ Optional IP66 from 90 A
- ▶ Integrated load break switch: AC-22 and AC-23 breaking capacity
- ▶ Chemical resistant GRP UL 94 casing up to 150 A
- ▶ Metal casing (IK09) from 90 A to 400 A with epoxy paint

TECHNICAL FEATURES

Plugs and sockets with integral load-break switching capability complying with IEC/EN 60309-1 and IEC/EN 60309-4 standards

	DS1	DS3	DS6	DS9	DS2	DS4
Rated current (In)	30 A	50 A	90 A	150 A	250 A	400 A
U _{max}	690 V	1 000 V	1 000 V	1 000 V	1 000 V	1 000 V
Power kW AC-22/AC-23	15 kW	30 kW	45 kW	80 kW	100 kW ⁽¹⁾	
AC-22 switching capability	16 A/690 V	32 A/690 V	63 A/690 V	150 A/400 V	250 A/400 V	
AC-23 switching capability	30 A/400 V	50 A/400 V	90 A/400 V	100 A/440 V	160 A/440 V	
Auxiliary contacts (optional)	2	4	4	6	6	
Keying positions	24	24	24	24	12	12
Ambient temperature	<<< -40°C to +60°C >>>					
Short-circuit current I _{cc}	<<< 10 kA >>>					

(1) 200 A 440 V

MOUNTING: LOAD BREAK RELEASE BUTTON SHOULD BE AT THE TOP

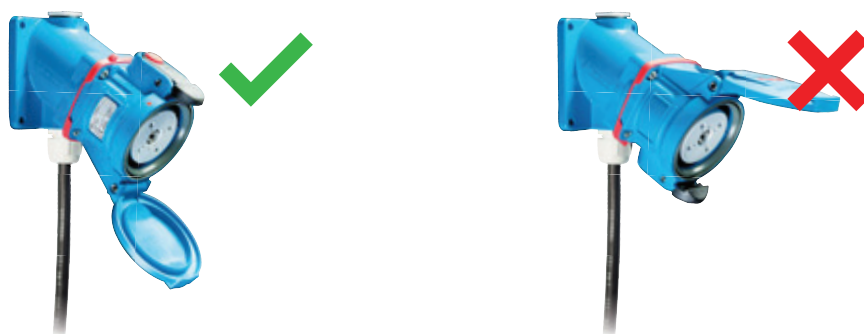

DS DECONTACTOR™ complies with:

- IEC/EN 60309-1 & IEC/EN 60309-4 European and International standards (plugs and socket-outlets for industrial purposes),
- The European Low Voltage Directive 2014/35/EU, conformity with the CE marking,
- The European 'Machine Directive' 2006/42/CE regarding equipment isolation,
- The French NF C 15-100 standard,
- The French decree dated 20 December 2011 pertaining to the wiring and operating conditions of movable electrical apparatuses,
- The decrees relating to workers' protection in Belgium, Spain and Italy,
- The switch utilization categories AC-22 A and AC-23 A described in IEC/EN 60947-3.
- The UL 1682 and 2682 (USA) and CSA C22.2 N° 182.1-07 (Canada) standards for plugs and socket-outlets.

Also certified by UL, TR CU (GOST), CCC and cCSAus (French, American, German, Russian, Chinese and Canadian inspection laboratories).



▶ 180° opening lid as standard

WALL MOUNTING SOCKET DS1

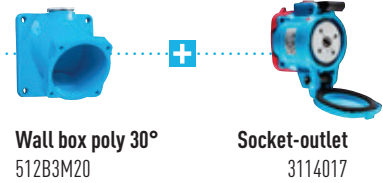

PLUG DS1

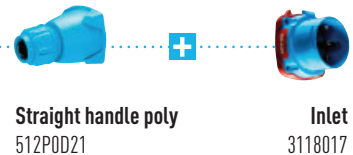

MAIN FEATURES

Rated current (with wiring according to standard)	30 A	Ambient temperature	-40 °C to +60 °C
Maximum voltage	690 V	Flexible wiring (min-max)	2,5-6 mm ²
IP protection lid closed	IP55	Stranded wiring (min-max)	2,5-10 mm ²
IP protection plug connected	IP54	Other wiring	on request
Shock resistance	IK08	Keying positions	24

Load-break capability of the DECONTACTOR™

Comply with IEC/EN 60309-1 and IEC/EN 60309-4 standards	30 A/690 V
Load-break capability according to IEC/EN 60947-3/AC-22 A	(30 A/500 V) or (16 A/690 V)
Load-break capability according to IEC/EN 60947-3/AC-23 A	30 A/400 V
Short-circuit current I _{cc}	10 kA
Power kW AC-22/AC-23	15 kW

SOCKET-OUTLET female DS1 (30 A)



INLET male DS1 (30 A)



Dual-voltage socket-outlet (see p. 7)

20-24 V AC	2P	311408A	311808A
220-250 V AC	1P+N+E	3114015	3118015
380-440 V AC	3P+E	3114013	3118013
220-250 V AC 380-440 V AC	3P+N+E	3114017	3118017
660-690 V AC	3P+E	3114193	3118193
380-400 V AC 660-690 V AC	3P+N+E	3114197	3118197
Up to 500 V AC - Auxiliaries 30 A	+ 2 contacts	Ref. + 972	Ref. + 972

▶ Other voltages, frequencies and contact configurations are available (see page 10).



For a black colour GRP housing replace the second reference character 1 with 5.

INFO+

OPTIONS AND ACCESSORIES

Find the boxes, sleeves and handles at the end of the section page 45.





▶ 180° opening lid as standard

WALL MOUNTING SOCKET DS3



Wall box poly 30°
513B3M25



Socket-outlet
3134017

PLUG DS3



Straight handle poly
513P0D30



Inlet
3138017

MAIN FEATURES

Rated current (with wiring according to standard)	50 A	Ambient temperature	-40 °C to +60 °C
Maximum voltage	1 000 V	Flexible wiring (min-max)	6-16 mm ²
IP protection lid closed	IP55	Stranded wiring (min-max)	10-25 mm ²
IP protection plug connected	IP54	Other wiring	on request
Shock resistance	IK08	Keying positions	24

Load-break capability of the DECONTACTOR™

Comply with IEC/EN 60309-1 and IEC/EN 60309-4 standards	(50 A/690 V) or (45 A/1 000 V)
Load-break capability according to IEC/EN 60947-3/AC-22 A	32 A/690 V
Load-break capability according to IEC/EN 60947-3/AC-23 A	50 A/400 V
Short-circuit current I _{cc}	10 kA
Power kW AC-22/AC-23	30 kW

SOCKET-OUTLET female DS3 (50 A)



INLET male DS3 (50 A)



Dual-voltage socket-outlet (see p. 7)

20-24 V AC	2P	313408A	313808A
220-250 V AC	1P+N+E	3134015	3138015
380-440 V AC	3P+E	3134013	3138013
220-250 V AC / 380-440 V AC	3P+N+E	3134017	3138017
660-690 V AC	3P+E	3134193	3138193
380-400 V AC / 660-690 V AC	3P+N+E	3134197	3138197
1 000 V AC	3P+E	3134223	3138223
Auxiliaries 16 A/400 V AC	+ 2 contacts	Ref. + 972	Ref. + 972
Auxiliaries 16 A/400 V AC	+ 4 contacts	Ref. + 264	Ref. + 264

▶ Other voltages, frequencies and contact configurations are available (see page 10).



For a black colour GRP housing replace the second reference character 1 with 5.

INFO+

OPTIONS AND ACCESSORIES

Find the boxes, sleeves and handles at the end of the section page 45.





WALL MOUNTING SOCKET DS6

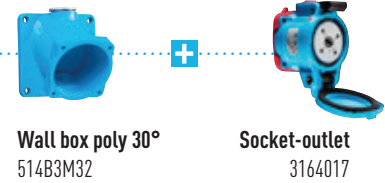

PLUG DS6

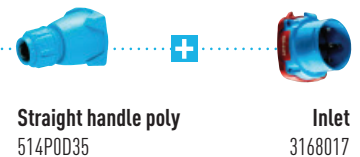

MAIN FEATURES

Rated current (with wiring according to standard)	90 A	Ambient temperature	-40 °C to +60 °C
Maximum voltage	1 000 V	Flexible wiring (min-max)	10-25 mm ²
IP protection lid closed	IP55	Stranded wiring (min-max)	10-35 mm ²
IP protection plug connected	IP54	Other wiring	on request
Shock resistance (poly casing)	IK08	Keying positions	24

Load-break capability of the DECONTACTOR™

Comply with IEC/EN 60309-1 and IEC/EN 60309-4 standards	(90 A/690 V) or (63 A/1 000 V)
Load-break capability according to IEC/EN 60947-3/AC-22 A	63 A/690 V
Load-break capability according to IEC/EN 60947-3/AC-23 A	90 A/400 V
Short-circuit current I _{cc}	10 kA
Power kW AC-22/AC-23	45 kW

SOCKET-OUTLET female DS6 (90 A)



INLET male DS6 (90 A)



Dual-voltage socket-outlet (see p. 7)

220-250 V AC	1P+N+E	3164015	3168015
380-440 V AC	3P+E	3164013	3168013
220-250 V AC / 380-440 V AC	3P+N+E	3164017	3168017
660-690 V AC	3P+E	3164193	3168193
380-400 V AC / 660-690 V AC	3P+N+E	3164197	3168197
1 000 V AC	3P+E	3164223	3168223
Auxiliaries 5 A/500 V AC	+ 2 contacts	Ref. + 972	Ref. + 972
Auxiliaries 5 A/500 V AC	+ 4 contacts	Ref. + 264	Ref. + 264
For IP66/67		Ref. + 600	Ref. + 600

▶ Other voltages, frequencies and contact configurations are available (see page 10).

i

For a black colour GRP housing replace the second reference character 1 with 5.

INFO+

OPTIONS AND ACCESSORIES

Find the boxes, sleeves and handles at the end of the section page 45.





WALL MOUNTING SOCKET DS6



Wall box metal 30°
594B2M25

Socket-outlet
3964017

PLUG DS6



Straight handle poly
514POD35

Inlet
3968017

MAIN FEATURES

Rated current (with wiring according to standard)	90 A	Ambient temperature	-40 °C to +60 °C
Maximum voltage	1 000 V	Flexible wiring (min-max)	10-25 mm ²
IP protection lid closed	IP55	Stranded wiring (min-max)	10-35 mm ²
IP protection plug connected	IP54	Other wiring	on request
Shock resistance (metal casing)	IK09	Keying positions	24

Load-break capability of the DECONTACTOR™

Comply with IEC/EN 60309-1 and IEC/EN 60309-4 standards	(90 A/690 V) or (63 A/1 000 V)
Load-break capability according to IEC/EN 60947-3/AC-22 A	63 A/690 V
Load-break capability according to IEC/EN 60947-3/AC-23 A	90 A/400 V
Short-circuit current I _{cc}	10 kA
Power kW AC-22/AC-23	45 kW

SOCKET-OUTLET female DS6 (90 A)



INLET male DS6 (90 A)



Dual-voltage socket-outlet (see p. 7)

220-250 V AC	1P+N+E	3964015	3968015
380-440 V AC	3P+E	3964013	3968013
220-250 V AC 380-440 V AC	3P+N+E	3964017	3968017
660-690 V AC	3P+E	3964193	3968193
380-400 V AC 660-690 V AC	3P+N+E	3964197	3968197
1 000 V AC	3P+E	3964223	3968223
Auxiliaries 5 A/500 V AC	+ 2 contacts	Ref. + 972	Ref. + 972
Auxiliaries 5 A/500 V AC	+ 4 contacts	Ref. + 264	Ref. + 264
For IP66/67		Ref. + 600	Ref. + 600

► Other voltages, frequencies and contact configurations are available (see page 10).

INFO+

OPTIONS AND ACCESSORIES

Find the boxes, sleeves and handles at the end of the section page 45.





► 180° opening lid as standard



WALL MOUNTING SOCKET DS9



Wall box metal 30°
595E3M50



Socket-outlet
3194017

PLUG DS9



Straight elastomer
555P0D35



Inlet
3198017

MAIN FEATURES

Rated current (with wiring according to standard)	150 A	Ambient temperature	-40 °C to +60 °C
Maximum voltage	1 000 V	Flexible wiring (min-max)	25-70 mm ²
IP protection lid closed	IP66/IP67/IP69	Stranded wiring (min-max)	25-95 mm ²
IP protection plug connected	IP66/IP67/IP69	Keying positions	24
Shock resistance (poly casing)	IK08		

Load-break capability of the DECONTACTOR™

Comply with IEC/EN 60309-1 and IEC/EN 60309-4 standards	(150 A/500 V) or (150 A/690 V)
Load-break capability according to IEC/EN 60947-3/AC-22 A	(90 A/690 V) or (150 A/400 V)
Load-break capability according to IEC/EN 60947-3/AC-23 A	100 A/440 V
Short-circuit current I _{cc}	10 kA
Power kW AC-22/AC-23	80 kW

SOCKET-OUTLET female DS9 (150 A)



INLET male DS9 (150 A)



Dual-voltage socket-outlet (see p. 7)

220-250 V AC	1P+N+E	3194015	3198015
380-440 V AC	3P+E	3194013	3198013
220-250 V AC 380-440 V AC	3P+N+E	3194017	3198017
660-690 V AC	3P+E	3194193	3198193
380-400 V AC 660-690 V AC	3P+N+E	3194197	3198197
1 000 V AC	3P+E	3194223	3198223
Auxiliaries 10 A/400 V AC	+ 2 contacts	Ref. + 262	Ref. + 262
Auxiliaries 10 A/400 V AC	+ 4 contacts	Ref. + 264	Ref. + 264
Auxiliaries 10 A/400 V AC	+ 6 contacts	Ref. + 976	Ref. + 976

► Other voltages, frequencies and contact configurations are available (see page 10).



For a black colour GRP housing replace the second reference character 1 with 5.

INFO+

OPTIONS AND ACCESSORIES

Find the boxes, sleeves and handles at the end of the section page 45.





WALL MOUNTING SOCKET DS9

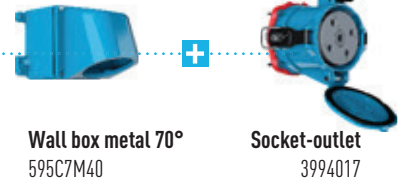

Wall box metal 70°
595C7M40

Socket-outlet
3994017

PLUG DS9

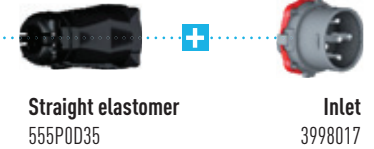

Straight elastomer
555P0D35

Inlet
3998017

MAIN FEATURES

Rated current (with wiring according to standard)	150 A	Ambient temperature	-40 °C to +60 °C
Maximum voltage	1 000 V	Flexible wiring (min-max)	25-70 mm ²
IP protection lid closed	IP55	Stranded wiring (min-max)	25-95 mm ²
IP protection plug connected	IP54	Keying positions	24
Shock resistance (metal casing)	IK09		

Load-break capability of the DECONTACTOR™

Comply with IEC/EN 60309-1 and IEC/EN 60309-4 standards	(150 A/500 V) or (150 A/690 V)
Load-break capability according to IEC/EN 60947-3/AC-22 A	(90 A/690 V) or (150 A/400 V)
Load-break capability according to IEC/EN 60947-3/AC-23 A	100 A/440 V
Short-circuit current I _{cc}	10 kA
Power kW AC-22/AC-23	80 kW

SOCKET-OUTLET female DS9 (150 A)



INLET male DS9 (150 A)



Dual-voltage socket-outlet (see p. 7)

220-250 V AC	1P+N+E	3994015	3998015
380-440 V AC	3P+E	3994013	3998013
220-250 V AC / 380-440 V AC	3P+N+E	3994017	3998017
660-690 V AC	3P+E	3994193	3998193
380-400 V AC / 660-690 V AC	3P+N+E	3994197	3998197
1 000 V AC	3P+E	3994223	3998223
Auxiliaries 10 A/400 V AC	+ 2 contacts	Ref. + 262	Ref. + 262
Auxiliaries 10 A/400 V AC	+ 4 contacts	Ref. + 264	Ref. + 264
Auxiliaries 10 A/400 V AC	+ 6 contacts	Ref. + 976	Ref. + 976
For IP66/67		Ref. + 600	Ref. + 600

► Other voltages, frequencies and contact configurations are available (see page 10).

INFO+

OPTIONS AND ACCESSORIES

Find the boxes, sleeves and handles at the end of the section page 45.





WALL MOUNTING SOCKET DS₂



Wall box metal 60°
596E6M63



Socket-outlet
3924017

PLUG DS₂



Straight elastomer
556POD35



Inlet
3928017

MAIN FEATURES

Rated current (with wiring according to standard)	250 A	Ambient temperature	-40 °C to +60 °C
Maximum voltage	1 000 V	Flexible wiring (min-max)	70-95 mm ²
IP protection lid closed	IP55	Stranded wiring (min-max)	70-120 mm ²
IP protection plug connected	IP54	Keying positions	12
Shock resistance	IK09		

Load-break capability of the DECONTACTOR™

Comply with IEC/EN 60309-1 and IEC/EN 60309-4 standards	(250 A/500 V) or (200 A/690 V)
Load-break capability according to IEC/EN 60947-3/AC-22 A	(250 A/400 V) or (125 A/690 V)
Load-break capability according to IEC/EN 60947-3/AC-23 A	160 A/440 V
Short-circuit current I _{cc}	10 kA

SOCKET-OUTLET female DS₂ (250 A)



INLET male DS₂ (250 A)



Dual-voltage socket-outlet (see p. 7)

380-440 V AC	3P+E	3924013	3928013
220-250 V AC 380-440 V AC	3P+N+E	3924017	3928017
660-690 V AC	3P+E	3924193	3928193
380-400 V AC 660-690 V AC	3P+N+E	3924197	3928197
1 000 V AC	3P+E	3924223	3928223
Auxiliaries 5 A/400 V AC	3P+N+E + 2 contacts	Ref. + 972	Ref. + 972
Auxiliaries 5 A/400 V AC	3P+E + 4 contacts	Ref. + 174	Ref. + 174
Auxiliaries 5 A/400 V AC	3P+E + 6 contacts	Ref. + 976	Ref. + 976
For IP66/67		Ref. + 600	Ref. + 600

► Other voltages, frequencies and contact configurations are available (see page 10).

For more than 2 auxiliary contacts, please contact us.

INFO+

OPTIONS AND ACCESSORIES

Find the boxes, sleeves and handles at the end of the section page 45.



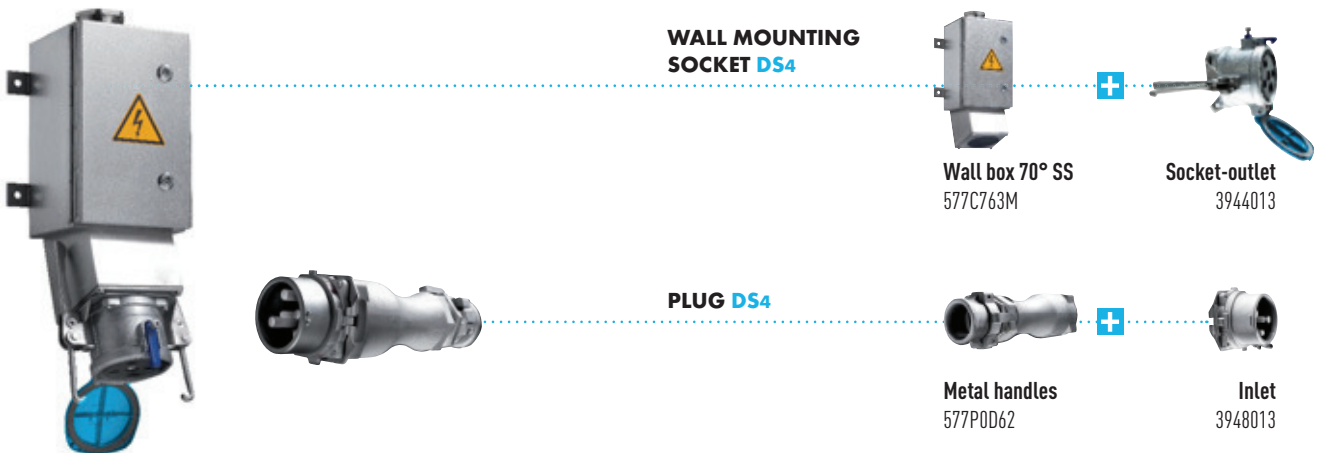

MAIN FEATURES

Rated current (with wiring according to standard)	400 A	Flexible wiring (min-max)	95-150 mm ²
Maximum voltage	1 000 V	Stranded wiring (min-max)	95-185 mm ²
Protection	IP54 (optional IP66/67)	Connector only: not to be disconnected while energised	
Shock resistance	IK09	Pilot contacts 5 A/400 V AC for electrical interlock	2
Ambient temperature	-40 °C to +60 °C	Mechanical interlock	as standard
Keying positions	12	Inlet closing device in stainless steel	as standard

SOCKET-OUTLET female DS4 (400 A)



INLET male DS4 (400 A)



380-440 V AC	3P+E+ 2pil.	3944013	3948013
660-690 V AC	3P+E+ 2pil.	3944193	3948193
1 000 V AC	3P+E+ 2pil.	3944223	3948223

REMEMBER TO ORDER AN OPTIONAL SPACER

Creates more space for easier wiring,
thickness 68 mm : 577M0-68,
thickness 115 mm : 577M0-115.

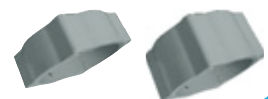

INFO+









OPTIONS AND ACCESSORIES

Find the boxes, sleeves and handles at the end of the section page 45.





OPTIONS (DETAILS ON PAGE 216)

	DS1 size 2	DS3 size 3	DS6 size 4	DS9 size 5	DS2 size 6	DS4 size 7
INDUSTRIAL-DOMESTIC ADAPTERS						
 Industrial inlet MARECHAL® 1P+N+E domestic socket-outlet 10/16 A 230 V fuse protection 10 A and 16 A.	3118015D11*	NA	NA	NA	NA	NA
	* All these plug adapters are available to foreign standards: replace D11 by D40 for UK, D30 for Germany/NL/Lux, D06 for Italy.					
LOCKING PIN FOR 2 PADLOCKS Ø 8 mm (PADLOCKS NOT SUPPLIED)						
	Socket-outlet ref. + 844	Socket-outlet ref. + 844	Socket-outlet ref. + 843	Socket-outlet ref. + 844	Socket-outlet ref. + 843	Socket-outlet ref. + 843
SAFETY HASP FOR UP TO 6 PADLOCKS						
	873A541	873A541	873A541	873A541	873A541	873A541
LARGER RELEASE BUTTON						
	Socket-outlet ref. + 453	Socket-outlet ref. + 453	Socket-outlet ref. + 453	Socket-outlet ref. + 453		
INLET CAP						
 IP66/67	311A426	313A426	316A426			
 IP55				319A126	312A126	312A126
IN-LINE CONNECTIONS (A PAIR OF FINGER DRAW PLATES TO AID CLOSING)						
	613A346	616A346	316A346			
180° OPENING LID						
Standard on poly housing	Standard	Standard	Metal socket ref. + 10	Metal socket ref. + 10	Metal socket ref. + 10	NA
SELF CLOSING/SELF RETURNING LID (ACCORDING TO MODEL)						
	Socket-outlet + R Closing IP55	Socket-outlet + R Closing IP55	GRP Socket-outlet + R Closing IP55	Socket-outlet + R Returning IP40	Socket-outlet + R Returning IP40	Socket-outlet + R Returning IP40
METAL SOCKET CASING WITH SELF RETURN & 180° OPENING LID						
			Socket-outlet ref. + 18	Socket-outlet ref. + 18	Socket-outlet ref. + 18	
SELF-CLOSING LID FOR INLET (IP54)						
	311A226	313A226	316A226			
IP66/67 SOCKET-OUTLET AND INLET (RECOMMENDED IN THE CASE OF COUPLER SOCKET)						
	NA	NA	Ref. + 600	Ref. metal + 600	Ref. + 600	Ref. + 600
SELF-EJECTING (SEE REFERENCES AND OPTIONS DETAILS PAGE 228)						
				Metal socket ref. +EMC	Metal socket ref. +EMC	Metal socket ref. +EMC
ELECTROMAGNETIC COMPATIBILITY (EMC) (SEE DETAIL PAGE 223)						



ACCESSORIES

(SEE PAGE 238 TO CROSS REFERENCE WITH OLDER PART NUMBERS)

BOXES



DS1
size 2

DS3
size 3

DS6
size 4



DS9
size 5

DS2
size 6

DS4
size 7



POLY BOX

	30°	M20	512B3M20					
	30°	M25	512B3M25	513B3M25				
	30°	M32			514B3M32			
	30°	M40			514B3M40			
	30°	M20	552B3M20					
	30°	M25	552B3M25	553B3M25				
	30°	M32			554B3M32			
	30°	M40			554B3M40			

METAL BOX (+ EARTHING WIRE)

	20°	M20	592B2M20	593B2M20				
	20°	M25	592B2M25	593B2M25	594B2M25			Ref. +EMC
	20°	M32		593B2M32	594B2M32			Ref. +EMC
	20°	M40			594B2M40			Ref. +EMC



POLY BOX + POLY SLEEVE (BLACK VERSION SEE ACCESSORIES DXN PAGE 169)

	70°	Without Hole	512C7000	513C7000	514C7000			
	70°	Ø M20	512C7M20					
	70°	Ø M25	512C7M25	513C7M25				
	70°	Ø M32	512C7M32	513C7M32	514C7M32			
	70°	Ø M40	512C7M40	513C7M40	514C7M40			

METAL BOX (+ EARTHING WIRE) + POLY SLEEVE

	30°	M20	512C3M20	513C3M20				
	30°	M25	512C3M25	513C3M25	514C3M25			
	30°	M32	512C3M32	513C3M32	514C3M32	515C3M32		
	30°	M40	512C3M40	513C3M40	514C3M40	515C3M40		
	30°	M50			514C3M50	515C3M50		
	30°	M63				515C3M63		

METAL BOXES WITH METAL SLEEVE (+ EARTHING WIRE)

	30°	M20	592C3M20	593C3M20				
	30°	M25	592C3M25	593C3M25	594C3M25			Ref. +EMC
	30°	M32	592C3M32	593C3M32	594C3M32	595C3M32		Ref. +EMC
	30°	M40		593C3M40	594C3M40	595C3M40		Ref. +EMC
	30°	M50			594C3M50	595C3M50		Ref. +EMC
	30°	M63				595C3M63		Ref. +EMC
	0°	M20	592C0M20	593C0M20				
	0°	M25	592C0M25	593C0M25	594C0M25			Ref. +EMC
	0°	M32	592C0M32	593C0M32	594C0M32	595C0M32		Ref. +EMC
	0°	M40		593C0M40	594C0M40	595C0M40		Ref. +EMC
	0°	M50			594C0M50	595C0M50		Ref. +EMC
	0°	M63				595C0M63		Ref. +EMC
	70°	M20		593C7M20				
	70°	M25		593C7M25	594C7M25			Ref. +EMC
	70°	M32		593C7M32	594C7M32	595C7M32		Ref. +EMC
	70°	M40		593C7M40	594C7M40	595C7M40		Ref. +EMC
	70°	M50			594C7M50	595C7M50		Ref. +EMC
	70°	M63				595C7M63		Ref. +EMC











ACCESSORIES

(SEE PAGE 238 TO CROSS REFERENCE WITH OLDER PART NUMBERS)

BOXES			DS1 size 2	DS3 size 3	DS6 size 4	DS9 size 5	DS2 size 6	DS4 size 7	
METAL BOXES WITH METAL SLEEVE (+ EARTHING WIRE)									
	0°	M50				595E0M50			Ref. +EMC
	30°	M50				595E3M50			Ref. +EMC
	30°	M63				595E3M63			Ref. +EMC
	70°	M50				595E7M50			Ref. +EMC
	70°	M63				595E7M63			Ref. +EMC
	60°	M50					596E6M50		Ref. +EMC
	60°	M63					596E6M63		Ref. +EMC
	60°	M75					596E6M75		Ref. +EMC
METAL BOXES WITH METAL SLEEVE AND METAL CABLE GLAND (+ EARTHING WIRE)									
	70°	35-46 mm						577C763M	
	70°	48-65 mm						577C775M	

SLEEVE		DS1 size 2	DS3 size 3	DS6 size 4	DS9 size 5	DS2 size 6	DS4 size 7	
POLY SLEEVE								
	30°	512M3	513M3	514M3	515M3			
	30°	552M3	553M3	554M3	555M3			
	70°	512M7	513M7	514M7				
	70°	552M7	553M7	554M7				
METAL SLEEVE								
	0°	592M0	593M0	594M0	595M0	596M0		Ref. +EMC
	30°	592M3	593M3	594M3	595M3			Ref. +EMC
	60°					596M6		Ref. +EMC
	60°						597M6	
	70°		593M7	594M7	595M7			Ref. +EMC

HANDLE		DS1 size 2	DS3 size 3	DS6 size 4	DS9 size 5	DS2 size 6	DS4 size 7	
POLY HANDLE WITH GLAND								
	5-21 mm	512P0D21						
	10-30 mm		513P0D30					
	13-35 mm			514P0D35				
	5-21 mm	552P0D21						
	10-30 mm		553P0D30					
	13-35 mm			554P0D35				
	40-63 mm					516P0D63		
ELASTOMER HANDLE WITH GLAND								
	18-25 mm				555P0D25			Ref. +443
	25-35 mm				555P0D35	556P0D35		Ref. +443
	35-45 mm				555P0D45	556P0D45		Ref. +443
	45-49 mm				555P0D49	556P0D49		Ref. +443
POLY HANDLE WITH POLY CABLE GLAND (BLACK COLOR VERSION REPLACE 1 BY 5)								
	5-12 mm	512P020P						Ref. +443
	9-18 mm	512P025P	513P025P					Ref. +443
	14-25 mm	512P032P	513P032P	514P032P	515P032P			Ref. +443
	18-32 mm	512P040P	513P040P	514P040P	515P040P			Ref. +443
	24-38 mm			514P050P	515P050P			Ref. +443
	35-48 mm				515P063P	516P063P		
POLY HANDLE WITHOUT CABLE GLAND (METRIC THREAD ENTRY, BLACK COLOR VERSION REPLACE 1 BY 5)								
	M20	512P0M20	513P0M20					Ref. +443
	M25	512P0M25	513P0M25					Ref. +443
	M32	512P0M32	513P0M32	514P0M32				Ref. +443
	M40	512P0M40	513P0M40	514P0M40				Ref. +443
	M50			514P0M50	515P0M50			
	M63				515P0M63	516P0M63		
	M75					516P0M75		

LEGEND FOR OPTIONAL ACCESSORIES







-  Angle
-  Threading or gland size
-  EMC option
-  HT 240° C
-  Self-ejection

INFO +



ACCESSORIES

(SEE PAGE 238 TO CROSS REFERENCE WITH OLDER PART NUMBERS)

HANDLE		DS1 size 2	DS3 - DSHT size 3	DS6 size 4	DS9 size 5	DS2 size 6	DS4 size 7	
METAL HANDLE WITH METAL GLAND (+ EARTHING WIRE)								
	7-13 mm	592P020M	593P020M					
	8-16 mm	592P025M	593P025M	594P025M				Ref. +EMC (9-16 mm)
	15-23 mm	592P032M	593P032M	594P032M	595P032M			Ref. +EMC (11-21 mm)
	22-32 mm		593P040M	594P040M	595P040M			Ref. +EMC (19-28 mm)
	34-44 mm			594P050M	595P050M			Ref. +EMC (27-35 mm)
	35-48 mm				595P063M			Ref. +EMC (34-45 mm)
	8-16 mm		573P025M185					
	15-23 mm		573P032M185					
METAL HANDLE WITH INTEGRATED CABLE CLAMP								
	40-54 mm					596P0D54		
	54-63 mm					596P0D63		
	53-57 mm						577P0D57	
	58-62 mm							577P0D62
	62-68 mm							577P0D68
	69-73 mm							577P0D73
METAL HANDLE WITHOUT CABLE GLAND (METRIC THREAD ENTRY)								
	M20	592P0M20	593P0M20					
	M25	592P0M25	593P0M25	594P0M25				Ref. +EMC
	M32	592P0M32	593P0M32	594P0M32	595P0M32			Ref. +EMC
	M40		593P0M40	594P0M40	595P0M40			Ref. +EMC
	M50			594P0M50	595P0M50	596P0M50		Ref. +EMC
	M63				595P0M63	596P0M63		Ref. +EMC
	M75					596P0M75		Ref. +EMC

LEGEND FOR OPTIONAL ACCESSORIES

-  Angle
-  Threading or gland size
-  EMC option
-  HT 240° C
-  Self-ejection



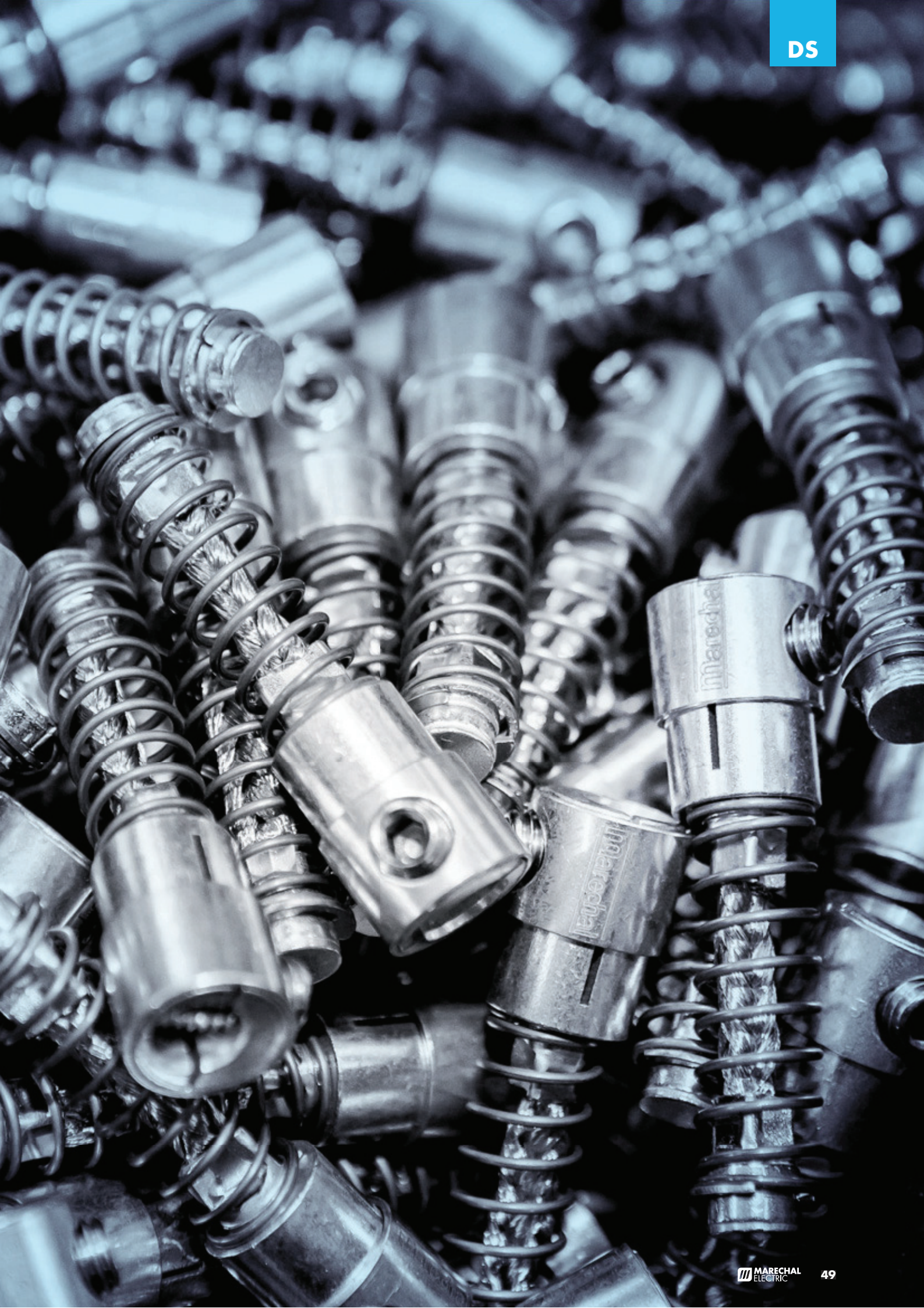

INFO +



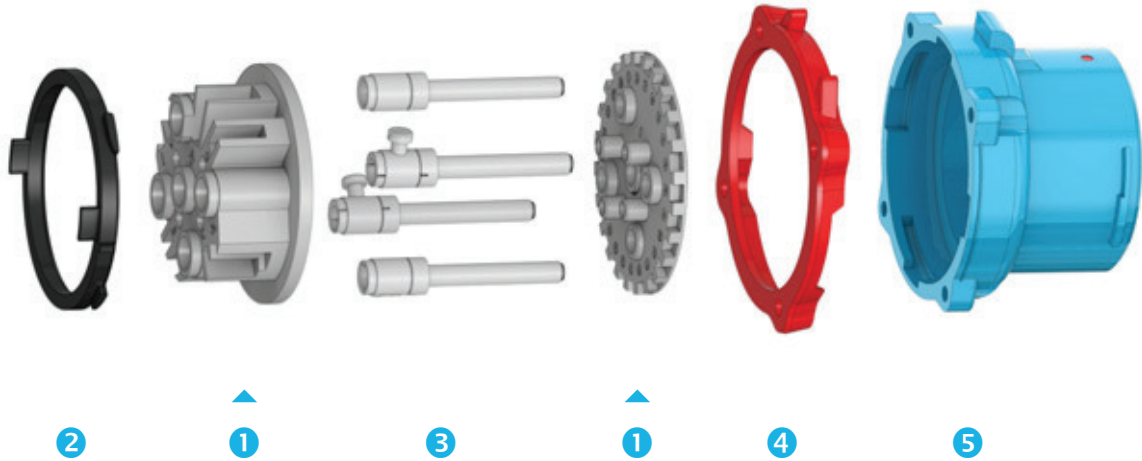

SPARE PARTS



PLUG	DS1	DS3	DS6	DS9	DS2	DS4	
1 Plug interior	311A010	313A010	316A010	619A010	-	-	
1 Plug interior metal + E	-	-	396A110	699A110	392A110	394A110	
2 Locking ring	311A583	313A583	316A583	319A583	-	-	
2 Locking ring metal	-	-	396A583	399A583	392A583	394A583	
3 Plug contact (P or N)	311A011	616A011	316A011	619A011	392A011	394A011	
4 Color-coded voltage gasket		311AB26	313AB26	316AB26	319AB26	392AB26	-
		311AR26	313AR26	316AR26	319AR26	392AR26	-
		311AV26	313AV26	-	-	-	-
		311AN26	313AN26	316AN26	319AN26	392AN26	-
5 Plug casing poly	311A501	313A501	316A501	619A501	-	-	
5 Plug casing metal	-	-	396A501	399A501	392A501	394A501	





Remember to order the special removal key



Yellow disassembly key
For poly casing
31-A500-1

Contact us for spare parts.

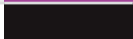

SOCKET	DS1	DS3	DS6	DS9	DS2	DS4	
1 Socket Interior poly	311A020	313A020	316A020	619A020	-	-	
1 Socket Interior metal +E			396A220	699A220	392A220	394A220	
2 Locking ring	311A583	313A583	316A583	319A583	-	-	
2 Locking ring metal	-	-	396A583	399A583	392A583	394A583	
3 Socket contact (P or N)	311A021	616A021	316A021	619A021	392A021	394A021	
4 Color-coded voltage gasket		311AB26	313AB26	316AB26	319AB26	392AB26	-
		311AR26	313AR26	316AR26	319AR26	392AR26	-
		311AV26	313AV26	-	-	-	-
		311AN26	313AN26	316AN26	319AN26	392AN26	-
5 Plug casing poly	311A524	313A524	316A524	619A524	-	-	
5 Metal Socket Lid Gasket	-	-	396A524	399A524	392A524	394A524	
6 Lid gasket	311A563	313A563	316A563	399A563 (metal) 619A074 (poly)	392A563	392A563	

Contact us for spare parts.



DIMENSIONS

DS1/DS3/DS6

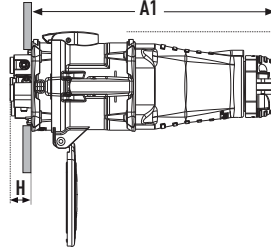
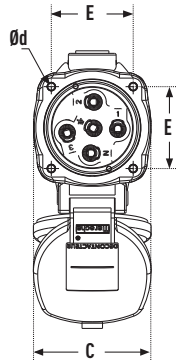
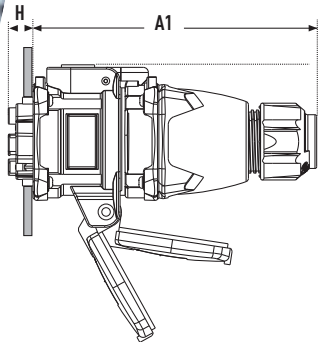

DS9/DS2

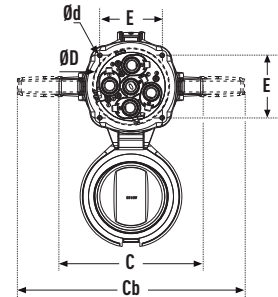

	A1	C	Cb	E	H	Ød*
DS1	166	69	/	48	15	5
DS3	179	80	/	55	17	5
DS6	203	95	/	66	25	5,5
DS9 POLY	315	186	294	81	26	6
DS2	360	192	304	98	38	6,5

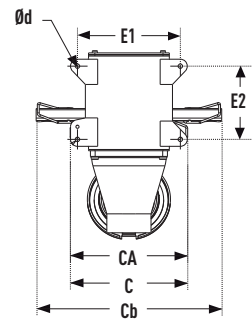
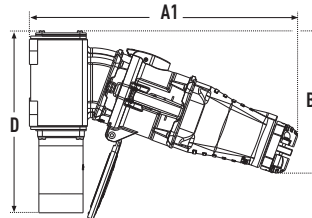
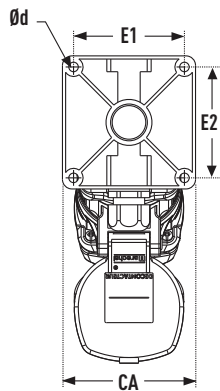
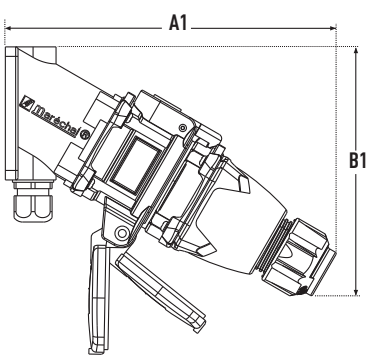

	A1	B1	CA	E1	E2	Ød*
DS1	209	157	84	70	70	6
DS3	235	181	89	77	88	6,5
DS6	283	215	105	89	112	7,5
DS9 POLY (20°)	425	225	185	163	116	7
DS2 (60°)	414	460	226	202	154	10

*Ød : maximum drilling diameter.

DS1/DS3/DS6

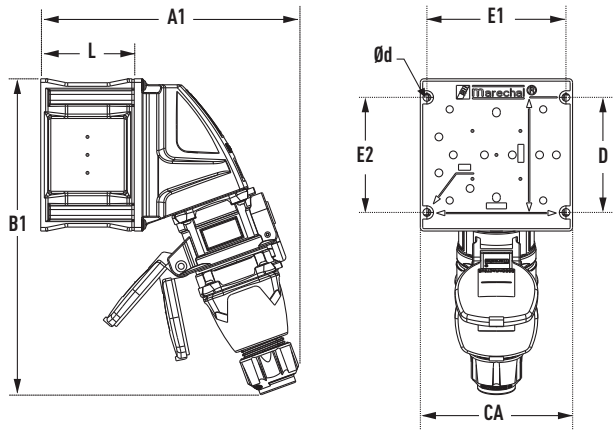

DS9/DS2

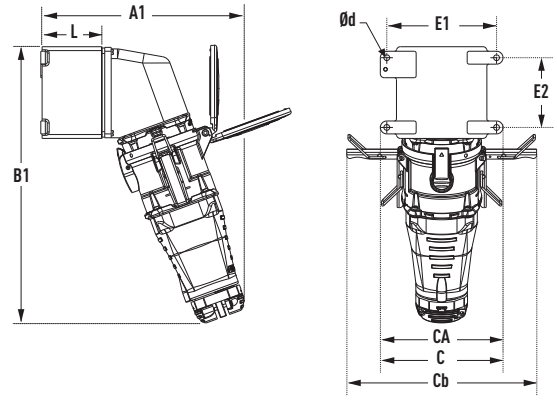

	A1	B1	Cb	CA	D	E1	E2	L	Ød*
DS1	216	263		128	128	116	96	78	6
DS3	243	313		170	170	158	139	78	6.5
DS6	250	338		170	170	158	139	78	8.5
DS9 POLY	315	430	294	190	142	170	108	95	9

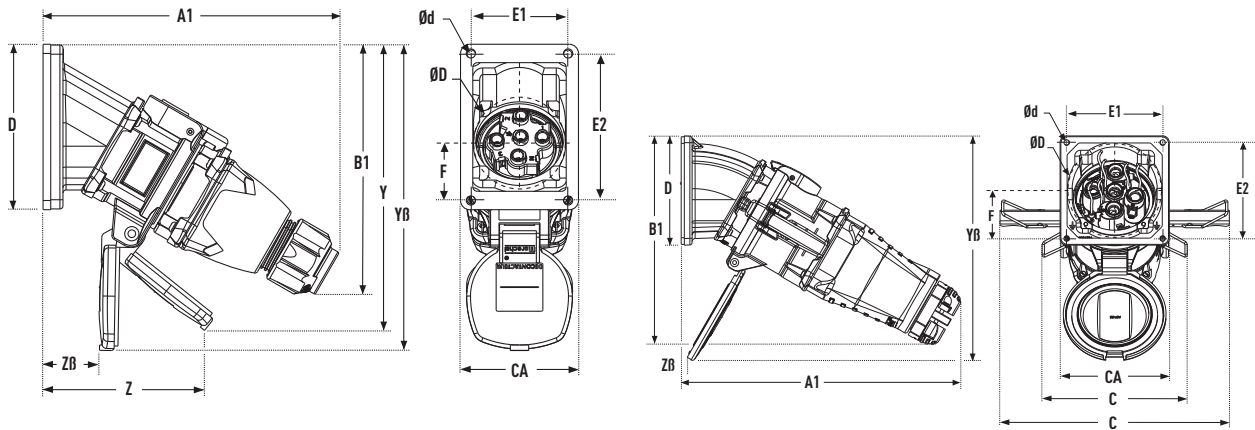

	A1	B1	CA	D	E1	E2	Ød*	ØD max
DS1	193	163	77	108	63	95	5,5	60
DS3	208	174	77	108	63	95	5,5	60
DS6	233	205	102	136	87	122	6,5	70

	A1	B1	C	CB	CA	D	E1	E2	Ød*	ØD max
DS9 POLY (30°)	358	267	186	294	140	140	124	124	7	120
DS2 (60°)	295	460	192	304	191	191	165	165	7	145

*Ød : maximum drilling diameter.

DS1/DS3/DS6

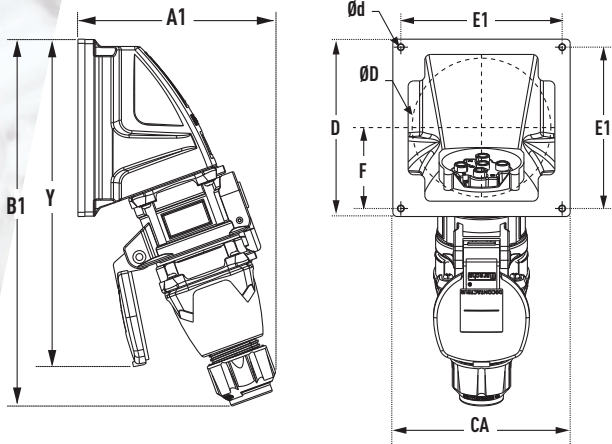

DS9/DS2

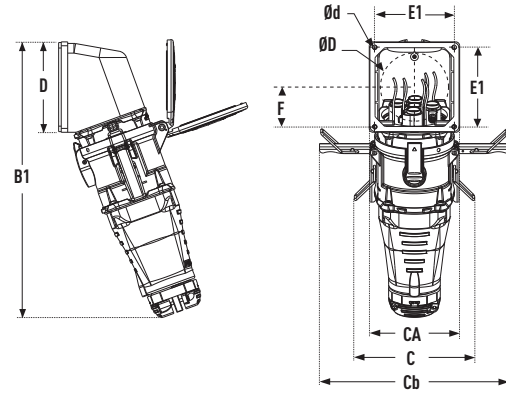

	A1	B1	CA	D	E1	Ød*
DS1	140	264	128	128	116	5
DS3	170	313	170	170	159	5
DS6	175	338	170	170	159	5

	A1	B1	C	Cb	CA	D	E1	Ød*
DS9 POLY	220	427	186	294	140	140	124	7

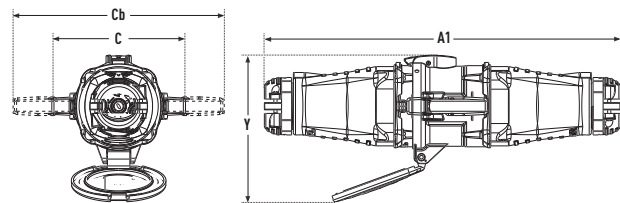
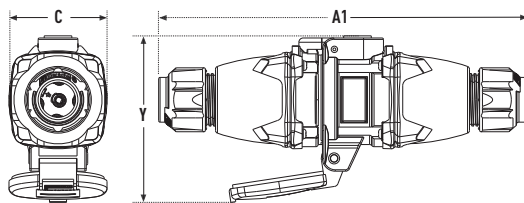

	A1	C	Y
DS1	259	69	117
DS3	277	80	145
DS6	309	95	167

	A1	C	Cb	Y
DS9 POLY	496	186	294	204
DS2	588	192	304	203

*Ød : maximum drilling diameter.

DS4

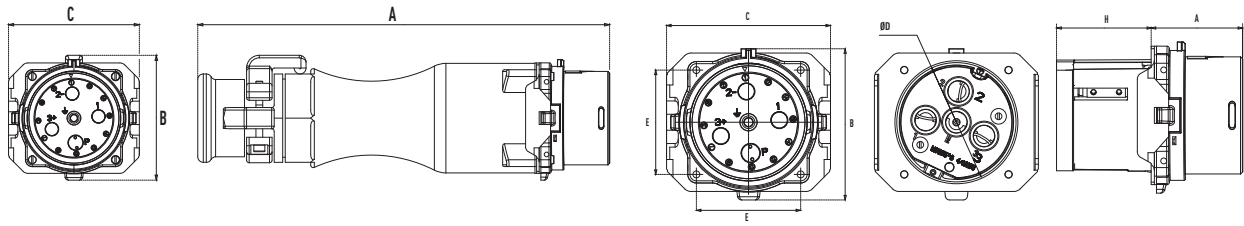

	A	B	C
DS4	485	147	154

	A	B	C	E	H	ØD max
DS4	86	89	154	142	98	112

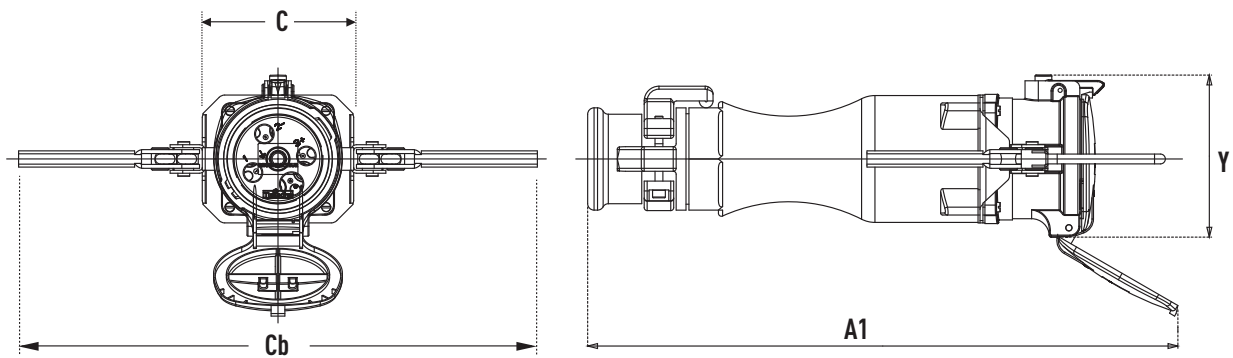

	A1	C	Cb	Y
DS4	600	224	528	165

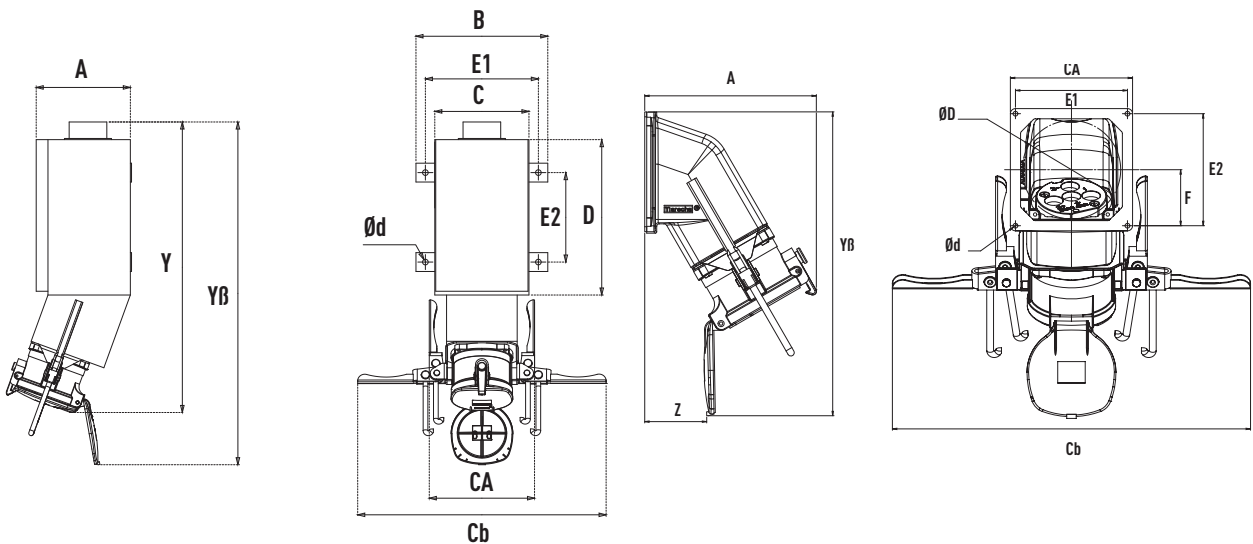

	A	B	C	CA	Cb
DS4	200	280	200	224	528
	E1	E2	Y	YB	Ød*
DS4	240	190	627	779	12

	A	CA	Cb	E1	E2
DS4	255	191	528	165	165
	F	YB	Z	Ød*	ØD max
DS4	82,5	448	85	7	145

*Ød : maximum drilling diameter.